

PORTABLE HIGH-PERFORMANCE BIO-RESONATOR



Art. no. 20145

Rayocomp PS 10

USER MANUAL



Table of contents

1. The Rayocomp PS 10	5
1.1. Intended use.....	5
1.2. Conformity assessment.....	5
1.3. Conformity declaration	5
2. Basics of the Rayocomp PS 10	6
2.1. Scope of delivery.....	6
2.2. Technical data	6
2.3. Instructions for use of the manual.....	7
2.4. General advice and safety instructions.....	8
2.5. Symbols used for Rayocomp PS 10.....	12
2.6. Manufacturer's declaration of electromagnetic compatibility IEC 60601-1-2 for the Rayocomp PS 10 ..	13
2.7. Guarantee	18
2.8. Transport and storage conditions	18
2.9. Cleaning / Servicing	19
2.10. Understanding the device	20
2.10.1 Front view.....	20
2.10.2 Rear view	21
2.10.3 Keyboard.....	22
2.10.4 Display	23
2.10.5 Accessories	23
2.10.7 Testing before use	24
2.10.6 Disposal.....	24
3. User manual	25
3.1. General Directions for Operation	25
3.1.1 Charging the integrated power pack	25
3.1.2 Switching the device on and off	26
3.1.3 Selecting the menu with the Mode key	27
3.1.4 Functioning of the Mode button	28
3.1.5 Operating the Integrated Polariser and Rayotensor	31
3.1.6 Error display	32
3.1.7 Setting individual fundamental frequency values of BaPS in the menu item "Direct"	33
3.1.8 Automatic program sequence when using an RAH Green Card in menu item "Direct".....	34

4. Use of bioresonance according to Paul Schmidt in the field of wellness/well-being .35

4.1	Summary of the functions of the Rayotensor in BaPS:	36
4.2	Use of the BaPS in wellness/well-being	36
4.3	Testing range values	39
4.4.	The Green Card	40
4.4.1	Saving fundamental frequency values con a Green Card	40
4.4.2	Testing with Memory Card Values	40
4.4.3	Automatic harmonisation	41
4.4.4	Loading Fundamental Frequency Values from Memory Cards and Harmonising	42

5. "Setup" 43

5.1	Set-up of background illumination	43
5.2	Deleting double values in the F1 programs	44
5.3	Adjusting the "Attention" sound (Beep)	44
5.4	Pre-Setting the Test Range Values	45
5.5	The pre-setting of the harmonisation time for fundamental frequency values	45
5.6	Automatic switch-off at the end of harmonisation	46
5.7	Activating and Deactivating Modules	46
5.8	Storing Fundamental Frequency Values on Memory Cards	47
5.9	Displaying Memory Card Information	48
5.10	Providing Read-Protection for a Memory Card	49
5.11	Providing Write-Protection for a Memory Card	49
5.12	Deleting a Memory Card completely	49
5.13	Initialising a Memory Card	50
5.14	Motor Test Run of the Frequency Module	50
5.15	Battery test	51

6. "Info"52

6.1	Special Function Keys	53
6.1.1	Using the IF-keys	53
6.1.2	Using the 10.0-key	53

7. Summary of the Possible Error Messages 54

1. The Rayocomp PS 10

1.1. Intended use

The Rayocomp PS 10 is a bioresonance device for use in the wellness / well-being sector. The Rayocomp PS 10 is a non-medical device.



Please be advised that although the information, suggestions and possible solutions provided here are based on over 35 years of experience, they cannot replace a consultation with a physician. In addition, when using the Rayocomp devices, the advice of an experienced specialist in the respective field should be consulted during use! Since clinical studies are not yet available, it should not be used in pregnant women, nursing mothers, infants, children and adolescents.



There is no risk of danger if the device fails due to EM interference.



Illnesses that may be life-threatening always require a clear diagnostic clarification and its timely application by a specialist.

1.2. Conformity assessment



We confirm that our Rayocomp PS 10 product complies with the essential protection requirements of the Council Directive 2001/95/EC on general product safety as laid down in the Council Directives on electrical and electronic products.

The following audit standards, harmonised under the relevant Directives, were used for the assessment:

Low Voltage Directive 2014/35/EC - Electrical safety: EN 60601-1:2006 + A1:2013

EMC Directive 2014/30/EC Electromagnetic compatibility: EN 60601-1-2:2015

EN 61000-3-2:2014

EN 61000-3-3:2013

Directive 2011/65/EU RoHs on the restriction of the use of certain hazardous substances in electrical and electronic equipment

Directive 2011/65/EU RoHs on the restriction of the use of certain hazardous substances in electrical and electronic equipment

1.3 Conformity declaration

The product complies with the relevant directives. For each delivered product a declaration of conformity can be requested from Rayonex Biomedical GmbH.

2. Basics of the Rayocomp PS 10

2.1 Scope of delivery

The scope of delivery contains:	1. The Rayocomp PS 10
	2. Integrated polariser
	3. Integrated power pack
	4. Battery charger
	5. User Manual
	6. Transport case
	7. Packaging board

It is absolutely necessary to keep the packing; in case you have to return the device for maintenance, please send it back in its transport case and the cardboard box. If you do not do so, we do not provide any guarantee.

If the old packing material gets lost, we can replace it on request, liable to costs.

When sending back the device, please make sure that all additional parts and accessories are secured inside the case! In case you intend to send back the PS 10, please always include the appurtenant charging set.

2.2. Technical data

Weight of the Rayocomp PS 10:	1.6 kg
Weight including case and accessories:	9.7 kg
Height:	100 mm
Width:	160 mm
Depth:	260 mm
Power supply for charging:	100 – 240 V / 50 – 60 Hz alternating current, 4.8 V - 12 V / 0.8 V secondary direct current
Max. reception capacity for charging:	24 w
Battery:	7.2 V
Operation time with a fully charged power pack:	8 hours (at least)
Range of the operation temperature:	10 – 40 °C

Protection type IP21:

Protection against penetration of solid foreign bodies with a diameter > 12,5 mm

Protection against vertically dripping water

2.3 Instructions for use of the manual



Please read the instructions for use carefully!
Please heed all warnings and instructions, and follow them exactly.

Warnings in this document

Warnings contain security-related information. You will find warnings in the Warning and Safety Information section, as well as before the steps in the procedure that pose a risk to people or objects.



Hazards

Indicates an imminently hazardous situation which, if not avoided, results in death or serious injury.



Warning

Indicates a potential hazardous situation which, if not avoided, could result in death or serious injury.



Caution

Indicates a potential hazardous situation which, if not avoided, could result in minor or light injuries.



Note

Indicates useful tips for the procedure.



Type and source of the hazard

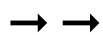

Measures/preventions

2.4 General advice and safety instructions

The following warning and safety information applies to general use of the device.

Risk of electric shock



Warning - Mains voltage

- Risk of electric shock when plugging cables into an electrical outlet.
 - → To avoid electric shock, cables must not be plugged into an electrical outlet.
 - → The device must be set up in such a way that the battery charger is always accessible, to ensure a safe mains separation.
 - → The PS10 charger may only be operated in a dry environment.
-



Warning - Insulation fault

- Risk of electric shock in case of damaged insulation of the device and the accessories.
 - → The device must be set up in such a way that liquids cannot penetrate the device or charger.
 - → If liquid does penetrate the device, the mains plug must be immediately plugged out and the device should be sent to the manufacturer for testing.
 - → Do not use cables with damaged insulation.
 - → The PS 10 may only be operated with accessories approved by the manufacturer and listed in the documents accompanying the PS 10.
-



Warning - Grounding fault

- Risk of electric shock when plugging cables into exposed conductive parts are not grounded or in case of unintentional grounding.
 - → The device must be connected with the delivered power supply.
 - → The power supply provided must only be connected to a power outlet with a protective earth.
 - → When the client is connected to the device, the detectors must not be placed on top of grounded objects (e.g. radiators), because this will lead to unintentional grounding of the client.
-

**Warning - Unintentional currents and leakage currents**

- There is risk of an electric shock or thermal injuries due to unintentional currents and leakage currents. The client must be insulated against all conductive parts.
 - → All unused cables should remain unplugged during and after use to prevent the client / operator from getting an electric shock.
 - → Prevent any persons, especially children, from poking sharp metal objects into the device.
 - → To completely disconnect the power supply, the mains plug must be plugged out of the earthing contact outlet because while the device may be switched off, it is still connected to the mains voltage.
 - → Contacts of the charger connection must not be touched simultaneously with the patient.
 - → The device must not be operated in conjunction with a multiple socket. The use of multiple sockets can lead to leakage currents being exceeded.
-

Warning - Damaging the display

- Mechanical damage to the display can cause a weak caustic fluid to leak out the device, which may cause injury.
 - → To avoid injury from a damaged display, avoid any contact with skin and eyes.
-

Risks associated with the device and accessories

**Warning - Incompatible accessories**

- Using incompatible accessories can harm the client/operator and damage the product.
 - → Use only Rayonex-approved accessories on the device and detectors.
 - → Use only Rayonex-approved accessories and those listed in the accompanying documents.
 - → The device may only be connected to the supplied charger.
-

**Warning - Damaged device and accessories**

- Using a damaged device/accessories, from a device/accessories that does not work properly or reusing disposable products, may result in electric shock, mechanical/thermal injury or infection of the client or operator.
 - → If the device or the components (housing, cables, charger) are damaged, the device should be taken out of operation.
 - → Do not use cables with damaged insulation.
 - → Avoid falls or blows in order to prevent damage to the device.
-

Operator-related error prevention



Hazard – Safety tests

- To ensure optimum performance and electrical safety, regular safety-related checks need to be performed on the device.
 - → No regular service intervals are required for the Rayocomp PS 10. This is based on the self-tests which the Rayocomp PS 10 performs automatically at each start. A periodic performance of safety-relevant tests regarding e-impedance, leakage currents, dielectric strength as well as visual inspection according to IEC 62353 must be planned by the operator himself and carried out by an authorized company.
 - → The device should only be opened by the manufacturer to guarantee its safety. Repairs, servicing or maintenance must only be performed by the manufacturer.
-

Risks related to environmental conditions



Warning – Not using the device in the intended environmental conditions

- Not using the device in the intended environmental conditions can negatively affect the basic safety of the device and give the client/operator an electric shock or cause mechanical/thermal injury. It can also damage the device.
 - → The device should be checked for transport damage before startup.
 - → The device should not be exposed to large fluctuations in temperature, as this may result in the formation of condensation. If the device (e.g., after transportation) is subject to extreme cooling (temperature under 5°C), or exposed to high levels of humidity, ensure that it is given enough time to acclimatise to the stated operating temperature range before switching it on again.
 - → The device should not be used in oxygen-enriched environments.
To avoid electric shock, cables must not be plugged into an electrical outlet.
 - → Prevent any persons, especially children, from poking sharp metal objects into the device.
 - → To completely disconnect the power supply, the mains plug must be plugged out of the earthing contact outlet, because while the device may be switched off, it is still connected to the mains voltage.
-



Warning - Suffocation

- There is a risk that children put the patient cable around their neck while playing and then step on the cable or get stuck with the cable -> the cable gets tightened, danger of suffocation.
 - → Cables must not lie around after use and children must not play with the device or accessories.
-

18.6.1 General information



Please be advised that although the information, suggestions and possible solutions provided here are based on over 35 years of experience, they cannot replace a consultation with a physician. Furthermore, the advice of an experienced specialist in the respective area should be consulted during treatment with the Rayocomp devices! Since clinical studies are not yet available, it should not be used in pregnant women, nursing mothers, infants, children and adolescents.



There is no risk of danger if the device fails due to EM interference.



Illnesses that may be life-threatening always require a clear diagnostic clarification and their timely treatment by a specialist.



The Rayocomp PS 10 BB does not have any performance features which, if they were to malfunction, would pose an unacceptable risk.



Videos (Rayonex Wiki) and training courses are offered to introduce the Rayocomp PS 10.



The Rayocomp PS 10 BB should not be serviced or undergo maintenance while being used on a client.



The presence of the Rayocomp PS 10 BB during application causes no known risks associated with mutual interference.



All connected devices (not in the direct vicinity of the client) must meet the requirements of EN 60950-1.



Repairs, servicing or maintenance must only be performed by the manufacturer. No action is required to ensure the long service life of the EMC.



The device should be kept away from other machines that emit HF interference.



Do not place anything on top of the device or put the device on top of any other equipment.



Non-original accessories can negatively affect EMC performance.



The device is not intended to be used with flammable anaesthetics and other flammable substances.















The service life of the device is at least 10 years.



The service life of the device is at least 10 years.

2.5 Symbols used for Rayocomp PS 10

	Serial number
	Article number
	Manufacturer
	Year of manufacture
	Range of the operation temperature
	Relative humidity (non-condensing)
	Air pressure
	Follow instructions for use.
	Store in a location protected from sunlight.
	Keep dry.
IP21	Protection against penetration of solid foreign bodies with a diameter > 12,5 mm Protection against vertically dripping water
	Disposal of electronic devices (no household waste)
	Protection category II: Double insulation (e.g. plastic housing)
	Type BF applied parts (detectors)

2.6 Manufacturer's declaration of electromagnetic compatibility IEC 60601-1-2 for the Rayocomp PS 10

Guidelines manufacturer's declaration - Electromagnetic emissions

for the device Rayocomp PS 10

The Rayonex Rayocomp PS 10 is intended for operation in an environment as described below. The user of the Rayocomp PS 10 must make sure that it is operated in this type of environment.

Emissions testing	Compliance	Electromagnetic environment - Guidelines
Radio frequency emissions (CISPR 11)	Group 1	The Rayonex Rayocomp PS 10 only uses high-frequency energy for its internal functions. Thus, it emits a low level of high-frequency energy and interference from electronic devices in the vicinity of the Rayocomp is unlikely.
HF emissions (CISPR 11)	Class B	The Rayonex Rayocomp PS 10 is suitable for operation in all environments, including residential building and facilities that are directly connected (without the use of a power transformer) to the same low-voltage network as residential buildings.
Harmonic current emissions (IEC 61000-3-2)	Class A	
Voltage fluctuations / Flicker (IEC 61000-3-3)	Is compliant	

Warning



- Between portable HF communication devices (radios) including their accessories such as external antennas and the Rayocomp PS 10 together with connected detectors, a minimum distance of 30 cm should be maintained. Non-observance can lead to a reduction in the performance characteristics of the device.
- → Maintain a minimum distance of 30 cm.

Warning



- Using this device directly next to other devices or with other devices in stacked form should be avoided, as this could result in incorrect operation. If it is nevertheless necessary to use it in the manner described above, this device and the other devices should be observed to ensure that they work properly.
- → Do not use directly next to other devices.
- → Do not use directly next to other devices in stacked form.

Guidelines manufacturer's declaration - Electromagnetic immunity
for the device Rayocomp PS 10

The Rayonex Rayocomp PS 10 is intended for operation in an environment as described below. The user of the Rayocomp PS 10 must make sure that it is operated in this type of environment.

Immunity test	IEC 60601 test level	Compliance level	Electromagnetic environment - Guidelines
Electrostatic discharge (ESD) (IEC 61000-4-2)	± 8 kV Contact discharge ± 2 kV, 4 kV, 8 kV, 15 kV Air discharge	± 8 kV Contact discharge ± 2 kV, 4 kV, 8 kV, 15 kV Air discharge	Floors should be made of wood or concrete, or ceramic tiles. If the floor is made of synthetic material, the relative humidity must be at least 30%.
Electrical fast transient / bursts (IEC 61000-4-4)	Mains lines: ± 2kV 100 kHz repetition rate	Mains lines: ± 2kV 100 kHz repetition rate	The quality of the supply voltage must correspond to a typical hospital or business environment.
	Signal input / signal output: ±1 kV 100 kHz repetition rate	Signal input / signal output: ±1 kV 100 kHz repetition rate	
Surge voltages / surges (IEC 61000-4-5)	Line to line: ±1 kV Line to ground: ± 2 kV	Line to line: ±1 kV Line to ground: ± 2 kV	The quality of the supply voltage must correspond to a typical hospital or business environment.
Voltage drops, voltage interruptions (IEC 61000-4-11)	0 % UT; 1/2 cycle at 0, 45, 90, 135, 180, 225, 270 and 315 degrees	0 % UT; 1/2 cycle at 0, 45, 90, 135, 180, 225, 270 and 315 degrees	The quality of the supply voltage must correspond to a typical hospital or business environment. If the operator of the Rayonex Rayocomp PS 10 needs uninterrupted operation of the device in case of failure of the operating voltage, we recommend connecting it to an uninterruptible electricity supply.
	0 % UT; 1 cycle and 70 % UT; 25/30 cycles single-phase: at 0 degrees	0 % UT; 1 cycle and 70 % UT; 25/30 cycles single-phase: at 0 degrees	
	0 % UT; 250/300 cycles	0 % UT; 250/300 cycles	

Magnetic fields at the supply frequency of (50/60) Hz (IEC 61000-4-8)	3 A / m / 50 Hz	3 A / m / 50 Hz	Magnetic fields at the network frequency should correspond to the typical values to be found in hospital and business environments.
---	-----------------	-----------------	---

Note: **UT** is the alternating mains voltage prior to application of level tests.

Conducted disturbances, induced by radio frequency fields. (IEC 61000-4-6)	3 V 0.15 MHz to 80 MHz 6 V in ISM and amateur radio frequency bands between 0.15 MHz to 80 MHz 80 % AM at 1 kHz	3 V 0.15 MHz to 80 MHz 6 V in ISM and amateur radio frequency bands between 0.15 MHz to 80 MHz 80 % AM at 1 kHz	Portable and mobile radio devices must not be used at distances from Rayocomp PS 10 (including its power line) of less than the recommended safety distance resulting from the respective transmission frequency equation.
High frequency electromagnetic fields (IEC 61000-4-3)	3 V/m 80 MHz to 2.7 GHz 80 % AM at 1 kHz	3 V/m 80 MHz to 2.7 GHz 80 % AM at 1 kHz	Recommended safety distance: $d=1.2\sqrt{P}$ $d=1.2\sqrt{P}$ 80 MHz to 800 MHz $d=2.3\sqrt{P}$ 800 MHz to 2.7 GHz where P is the maximum output power rating of the transmitter in watts (W) according to the transmitter manufacturer and D is the recommended separation distance in metres (m). The field strengths ^a of stationary radio transmitter at all frequencies must be lower than the compliance level according to an on-site test. ^b Near devices that bear this symbol, interferences are possible. 

Guidelines manufacturer's declaration - Electromagnetic immunity
for the device Rayocomp PS 10

The Rayonex Rayocomp PS 10 is intended for operation in an environment as described below. The user of the Rayocomp PS 10 must make sure that it is operated in this type of environment.

Immunity test	High frequency electromagnetic fields in direct vicinity to wireless communication devices		
Immunity Test / modulation	Test frequency / radio service	Compliance level	Electromagnetic environment - Guidelines
27 V/m PM 18 Hz	385 TETRA 400	27 V/m PM 18 Hz	Portable and mobile radio devices must not be used at distances from Rayocomp PS 10 (including its power line) of less than the recommended safety distance resulting from the respective transmission frequency equation. Recommended safety distance: $d=1.2\sqrt{P}$ $d=1.2\sqrt{P}$ 80 MHz to 800 MHz $d=2.3\sqrt{P}$ 800 MHz to 2.7 GHz where P is the maximum output power rating of the transmitter in watts (W) according to the transmitter manufacturer and D is the recommended separation distance in metres (m). The field strengths ^a of stationary radio senders at all frequencies must be lower than the compliance level according to an on-site test. Recommended separation distance between portable and mobile HF telecommunication devices and the Rayonex Rayocomp PS 10.
28 V/m for FM ± 5 kHz Hub 1 kHz Sine	450 GMRS 460, FRS 460	28 V/m for FM ± 5 kHz Hub 1 kHz Sine	
9 V/m PM 217 Hz	710 745 780 LTE Band 13, 17	9 V/m PM 217 Hz	
28 V/M PM 18 Hz	810 870 930 GSM 800/900, TETRA 800, iDEN 820, CDMA 850, LTE Band 5	28 V/M PM 18 Hz	
28 V/m PM 217 Hz	1720 1845 1970 GSM 1800, CDMA 1900, GSM 1900, DECT, LTE Band 1,3, 4, 25; UMTS	28 V/m PM 217 Hz	
28 V/m PM 217 Hz	2450 Bluetooth, WLAN 802.11 b/g/n, RFID 2450, LTE Band 7	28 V/m PM 217 Hz	
9 V/m PM 217 Hz	5240 5500 5785 WLAN 802.11 a/n	9 V/m PM 217 Hz	

→

			<p>The Rayonex Rayocomp PS 10 is intended for use in an electromagnetic environment, where RF disturbances are controlled. The operator of the Rayonex Rayocomp PS 10 can help reduce electromagnetic disturbances by maintaining a minimum distance of 30 cm between the Rayonex Rayocomp PS 10 and portable and mobile HF telecommunications devices (transmitters).</p>
--	--	--	--

The following notes refer to the above tables.

Note 1: the higher frequency range applies at 80 MHz and 800 MHz.

Note 2: these guidelines may not apply in all cases.

Electromagnetic propagation is affected by absorption and reflection from structures, objects and people.

^a It is not possible to accurately predict the theory related to the field strength of fixed transmitters, such as base stations for wireless telephones and land mobile radios, amateur radio stations, AM and FM radios and TV sets. To assess the electromagnetic environment created by fixed transmitters, a study of the electromagnetic phenomena of the location should be considered. If the measured field strength in the location in which the Rayonex Rayocomp PS 10 is used exceeds the RF compliance level above, the device should be monitored to verify normal operation. If abnormal performance is observed, additional measures may be necessary, such as changing the direction or location of the Rayonex Rayocomp PS 10.

^b Over the frequency range 150 kHz to 80 MHz, field strengths should be below 3 V/m.

2.7 Guarantee

The warranty period runs for one year from the date of delivery on and is only valid for devices that have not been opened, with the intact guarantee seal as evidence. Improper use of the device invalidates the warranty claim.

2.8 Transport and storage conditions



Transport conditions



Storage conditions



Humidity

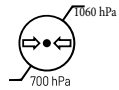



Air pressure

2.9 Cleaning / Servicing



The surface of the device should be cleaned with a soft cloth and a small amount of alcohol once a week. Never treat the device with strong cleaning agents.

The detectors, which come into close contact with the clients (i.e. hand and foot detectors), need cleaning after every use - preferably with alcohol.

	When in contact with possibly contagious clients all general hygienic measures apply! In the event of possible contact of the device with infectious materials, an appropriately effective disinfectant must be used.
	Do not submerge the device in fluids or running water. Do not use liquid or gaseous cleansers (sprays, abrasives, polish, etc.). Do not allow fluids to reach the device or the battery charger. If fluids do reach the device, pull out the battery charger immediately!

No regular service intervals are required for the Rayocomp PS 10. This is based on the self-tests which the Rayocomp PS 10 performs automatically at each start.

If there is still a problem with the device, this will be shown in the display after the self-test. In this case, please contact the Rayonex Biomedical on the following number (+49) 27216006-0.

	It is necessary to check the device, accessories and also the connection cable (especially the charger) regularly for damages by visual examination. If damage to the body, accessories or cables is detected, the device may only be operated after a manufacturer's inspection.
	No modifications or changes may be made to the device!

2.10 Understanding the device

In the chapters of this user manual, you will often find instructions referring to keys or segments of the Rayocomp PS 10. In the following, you can see pictures of the device accompanied by short descriptions in order to simplify the assignment.

2.10.1 Front view



Caption:

1: Display

2: Keyboard

3: Three exit hubs for connecting the hand, foot or used detectors and the measuring and protection cups

4: Rayotensor connection For a correct connection, please insert the Rayotensor plug and then fasten it by twisting the knurled screw.

5: Entry hub

6: Memory card insert

2.10.2 Rear view



Caption:

1: On/Off key

2: Charging socket

3: Interface for program updates

2.10.3 Keyboard

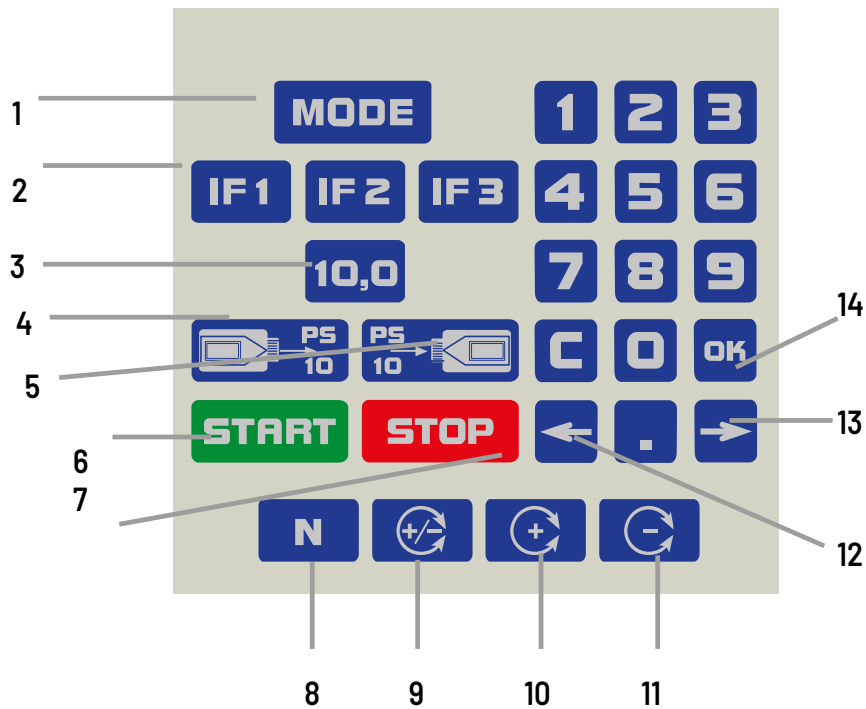

Legend:

- 1: "Mode" key for selecting the menu item
- 2: IF1 to IF3 keys: to save frequently used fundamental frequency values
- 3: 10.0 key for the rapid access to this value and for activating the test protocols / M10.
- 4: Key for loading the values from a memory card into the device
- 5: Key for storing values from the device on a memory card
- 6: Start key
- 7: Stop key for interrupting an automatic run or for deleting the function
- 8: N key of the polariser to switch the polariser to neutral
- 9: +/- key of the polariser to switch on the bipolar function
- 10: + key of the polariser to activate a polarisation rotating to the right
- 11: - key of the polariser to activate a polarisation rotating to the left
- 12: Arrow-left key, i.e. for selecting the RAH program during an automatic program course
- 13: Arrow-right key, i.e. for selecting the RAH program during an automatic program course
- 14: Numerical block for entering digits, numbers, C deletes, the decimal point indicates i.e. a program number (i.e. 01.00 Vitalisation).

2.10.4 Display

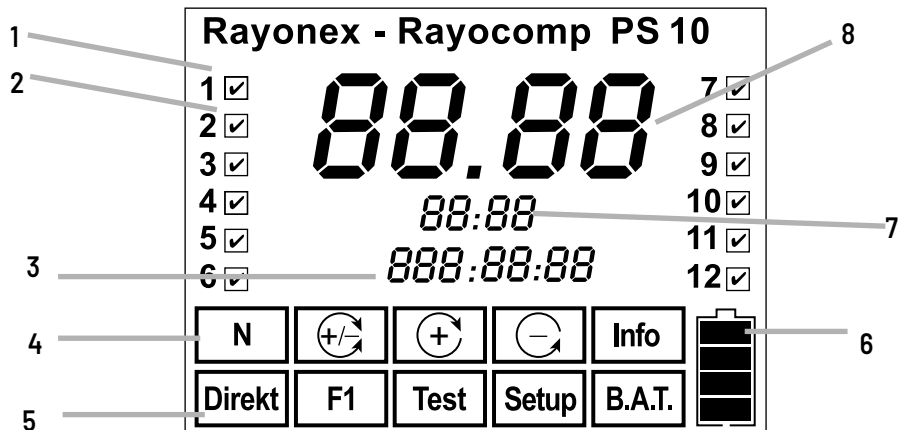

Caption:

- 1/2: Numbering the modules. All in all, the Rayocomp PS 10 is intended for the activation of twelve different modules. If the menu item "Info" is selected, it is displayed which modules are already activated. To use the range value test, you need module 06.
- 3: In the menu item "F1", you can read the remaining total harmonising time here.
- 4: This displays the polarisation type which is currently set.
- 5: Here you can read, which menu item has been selected.
- 6: This symbol shows you the charge status of the battery pack. If all four bars can be seen on the display, the accumulator is full. If no bar is indicated, the accumulator is empty.
- 7: During harmonisation with RAH-programs, the remaining duration of the harmonising appertaining to the current RAH-program will be shown at this place.
- 8: Here, the currently set fundamental frequency value to support a holistic well-being is indicated. We have selected a large numeral display for better reading comfort.

2.10.5 Accessories

Only accessories authorized by the company Rayonex Biomedical GmbH may be connected to the product. If you use accessories that are not authorised by Rayonex Biomedical GmbH, the device can be damaged or it may not perform its intended service.

The following accessories may be used with Rayocomp PS 10:

- Green Card (art. no. 359xx)
- Rayotensor with wooden handle (art. no. 362)
- Rayotensor bracket (art. no. 120)
- Foot detector protected (art. no. 31800)
- Hand detectors protected (art. no. 31900)
- Fitted sheet (art. no. 30323)



The use of other accessories is not intended!

2.10.6 Disposal

Disposal information for private users:

Caution: your device bears this symbol:



This means that at the end of their product life electrical and electronic devices must not be disposed of with household waste, but rather delivered to a separate collection system. By proper disposal you contribute to the appropriate collection, treatment and reuse of used devices. This prevents possible damaging effects on the environment and health due to improper disposal.

In the European Union:

Caution: do not dispose this device in the normal household garbage! According to the new EU directive that stipulates the proper collection, treatment and reuse of used electrical and electronic devices, used electrical and electronic devices must be disposed of separately. After the implementation of the directive in the EU member states, private households can now deliver their used electrical and electronic devices free of charge to the designated return points. In some countries used devices can also be turned in free of charge at the specialised dealer under certain circumstances if you purchase a comparable new device.

You can receive further details from your municipal administration or the local disposal point.

In other countries outside of the European Union:

Please inform yourself at your community administration or the local disposal station about the proper procedure for disposal of this device.

2.10.7 Testing before use

The Rayocomp PS 10, the battery charger, the accessories and the connection cables should all undergo visual inspection to check for any damage. If there is any damage to the housing, accessories or wiring, the device may only be put back into operation after it has been checked by the manufacturer.

3. User manual

3.1 General Directions for Operation

3.1.1 Charging the integrated power pack

The Rayocomp PS 10 is equipped with an integrated battery pack to enable the application of the device without needing to connect it to the mains supply. Please ensure that the PS 10 is switched off before charging the battery. If for whatever reason the PS 10 is turned on while charging, a warning message will appear on the display (Er 50) and the device will emit a beep sound.

An empty battery pack requires approx. 4 hours for complete charging. In order to avoid unnecessary electro-magnetic pollution, please unplug the charging unit when it is not being used.

And this is how you charge the Rayocomp PS 10:

1. Switch off the device.
2. Connect the charging unit to the mains supply
3. Plug the charging cable into the rear of the device (see chapter 2.10.2)
4. The charging unit indicates the various charging processes. When the LED turns green, the charging process is complete and you can use the device again.
5. Please disconnect both the plug from the rear panel of the device and the charging set from the electrical outlet.



Function	yellow	green
Standby: charging device in stand-by mode, ready to charge	glows	
Pre-charge: tests whether charging is required	blinks slowly	
Rapid charge: power pack is charged with constant current		blinks rapidly
Maintain: charging power is reduced		blinks slowly
Error: charging cannot start	blinks rapidly	
Ready: the Rayocomp PS 10 is ready for use		glows
Wait: charging device is not ready yet	blinks slowly	blinks slowly

Note: The charging status of the power pack is always displayed. This bar indicator allows you to estimate the length of time left for operation before it becomes necessary to recharge the device. The Rayocomp PS 10 cannot be charged during harmonisation.

3.1.2 Switching the device on and off

On the rear of the Rayocomp PS 10, you will find the key for switching the device on and off. When switching on, please make sure that no memory card is inserted in the device. In case your PS 10 is not under supervision for a longer period of time (overnight, for example), make sure that the power pack is charged sufficiently. **Total discharge, even if it happens only once, damages the power pack permanently.**



After the device is switched on, a short trial run is started.

A mechanical test is performed, along with a check of the power pack. If you receive the message "Er 29", the power pack must be recharged before you can work with the device. Then the device switches over to the menu item "Direkt" and is immediately ready for action.

The display shows:

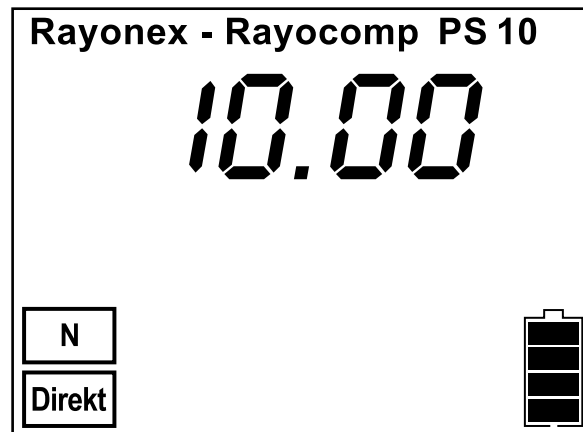

It is not necessary to move to a certain menu item before switching off the device. This means you can switch off the device at any time. Please keep in mind that the resonance values and the found RAH programs detected in the menu item "Test" are lost when the device is switched off. When the status of the power pack goes down until its functions can no longer be guaranteed, a 'blip' can be heard several times. **In this case, the power pack must be recharged immediately to avoid damage.**

Important information:

You cannot damage your device by switching it off arbitrarily. Neither will the integrated harmonising programs be lost nor will your hardware suffer damage.

3.1.3 Selecting the menu with the Mode key

The Rayocomp PS 10 has a selection of menu items. Every menu item provides certain application possibilities. Therefore, partitioning into single menu items serves as a means for simplifying operation. The following menu items are available:

1. Menu item "**Direct**": This menu item enables the automatic sequence of fundamental frequency values for wellness / well-being, which have been stored on a Green Card.
2. Menu item "**F1**": Under menu item F1, fundamental frequency values for wellness / well-being can be entered into the internal device memory of the Rayocomp PS 10, in order to either save them on a Green Card after entry or to use them directly for harmonisation. From Software version 59 the RAH Compact programs can be selected for harmonization under this menu if module 9 (M9,) 10 (M10) or module 11 (M11) are released.
3. Menu item "**Test**": This menu item provides all possibilities for testing fundamental frequency values. The range value test can be performed if module 06 was activated.
4. Menu item "**Setup**": This menu item is used to change presettings of the device, to obtain information about the memory cards, to activate the specific module 06 and to perform a general device test.
5. Menu item "**Info**": Select this menu item to gain information concerning the serial number of the device. It will also indicate the current state of the integrated software and the existing hardware.

3.1.4 Functioning of the Mode button

When the Rayocomp PS 10 is switched on, the display of the device shows the menu item "Direct":

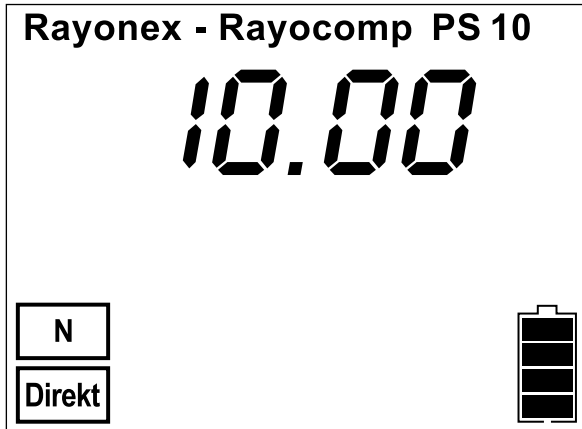

Now press the key: **MODE**

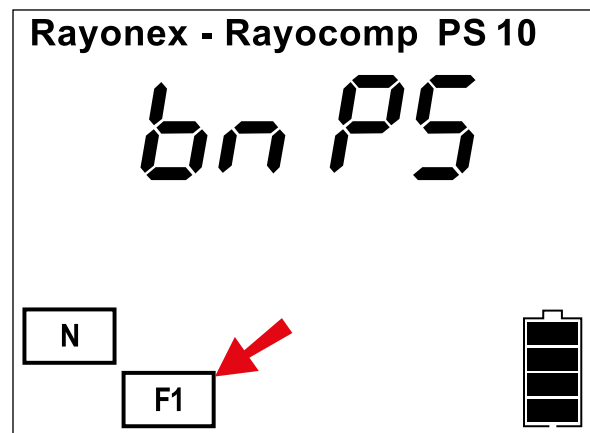

The Rayocomp PS 10 changes over to the menu item "F1-BnPS" and displays:

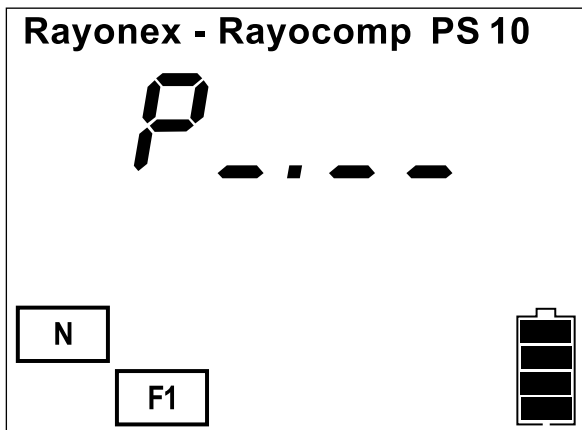

If now the Mode key is not pressed again for a short moment, the PS 10 will automatically start the input mask, allowing you to enter the BaPS programs.

Press the following key two times again: **MODE**

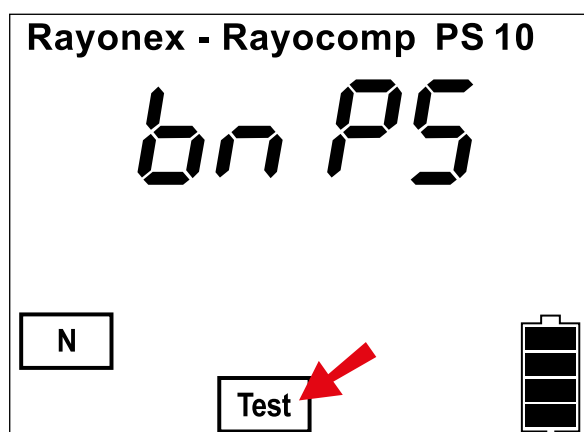

After having pressed **MODE** again, the Rayocomp PS 10 changes to the menu item "Test" and shows on the display:

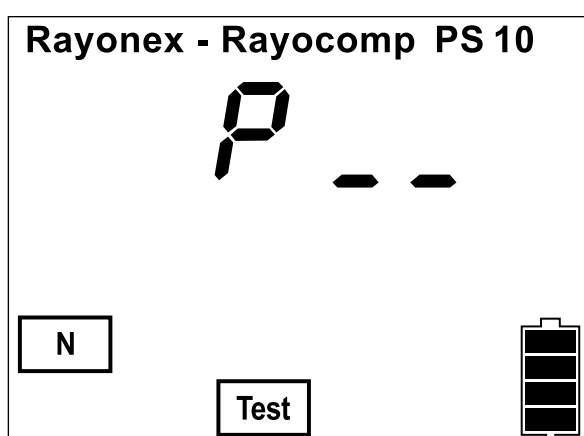

If the key "Mode" is not pressed once more, after having selected the menu item "Test-BaPS", the following prompt will appear:

Here, BaPS programs can be tested.

By pressing on the key "Mode" once again, this menu item can be selected.

Once again, press two times the key: **MODE**

The Rayocomp PS 10 changes to the menu item "Setup" and shows on the display:

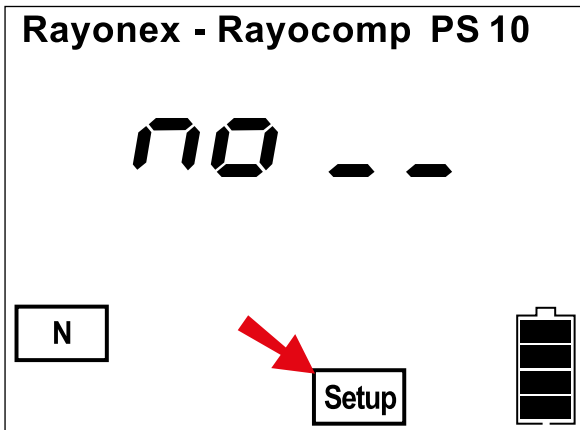

Once again, press the key: **MODE**

The Rayocomp PS 10 changes over to the menu item "Info" and displays:

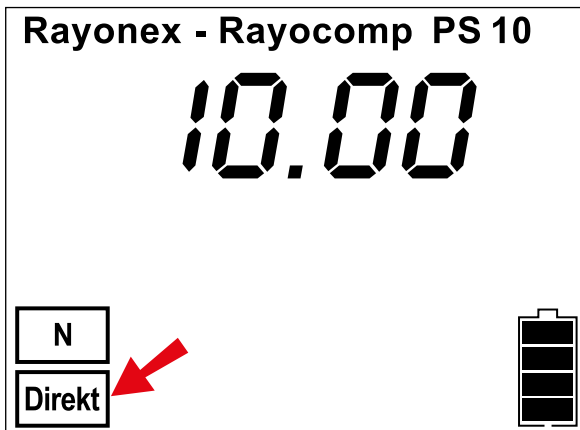
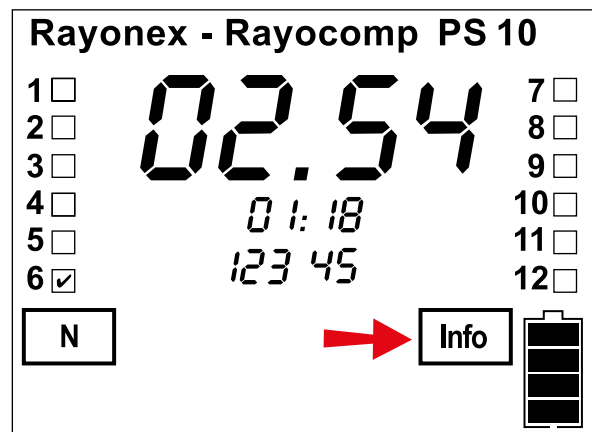

If you press the **MODE** key again you will move back to the menu item "Direct". Once more, the display will shows:

3.1.5 Operating the Integrated Polariser and Rayotensor

The Rayocomp PS 10 has a built-in polarizer, which considerably increases the ease of use.

The functions of the integrated polariser can be activated in two different ways, with the keyboard or the Rayotensor. Because the use of the keyboard is rather bothering when performing tests, we recommend using the button of the Rayotensor to carry out the functions of the integrated polariser right from the start.

Basically, the use of the polariser in connection with the Rayocomp PS 10 offers the following advantages:

- While testing, the polariser helps you to find out, whether a disturbance is strong or weak.
- Specially when harmonising, the bipolar function (+/-) intensifies the effect.

These four keys enable the utilisation of the polariser functions via keyboard:

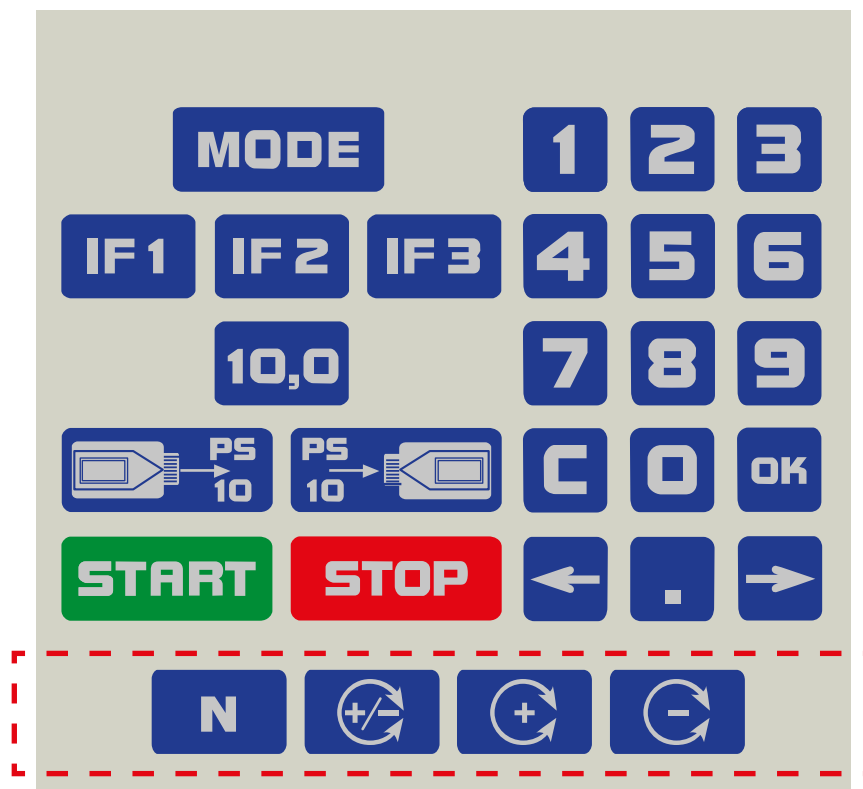

However, the functions of the polariser can also be set to the sensor directly while testing. Moving the Rayotensor button in direction of the connection cable backward, the current polarisation of the frequencies is altered.

3.1.6 Error display

Operation of the Rayocomp PS 10 is very simple indeed. Still, you may accidentally press a button which has no function for this particular part of the program. In this case, the user will receive an acoustic signal.

The Rayocomp PS 10 has three different error messages or acoustic signals:

1. **One long sound:** with this signal, the device confirms a successfully completed action, i.e. an entry or storage.
2. **Two short sounds:** The key you are pressing has no current function.
3. **Two long sounds:** This signals a severe error. The device will supply an error code. In the appendix (chapter 7), you can look up the current error.

For example, if an error has been detected, the device might indicate the following:

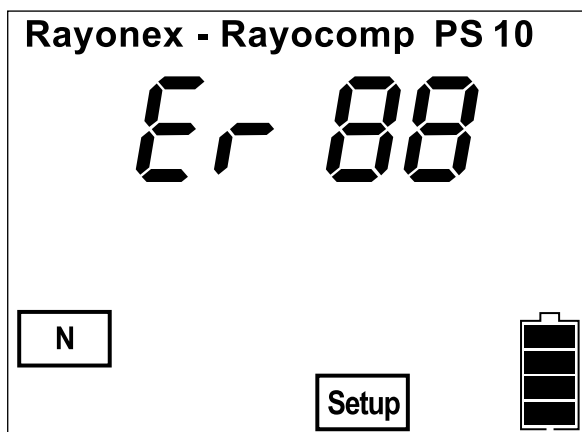

If you look into the list in chapter 7, you will find the following information for the indicated error "Er 88" ("Er" is the abbreviation for error): you have tried to read in a memory card which has not been inserted.

Please note: The acoustic signal can be switched on or off in the menu item "Setup".

3.1.7 Setting individual fundamental frequency values of BaPS in the menu item "Direct"

The menu item "Direct" is used to enter individual fundamental frequency values of the BaPS. Enter the value with the help of the keyboard and confirm with the **OK** key. The device adjusts the value automatically.

Example: Setting the fundamental frequency value 99.50

After switching on your device, you arrive in the menu item "Direct". The display shows:

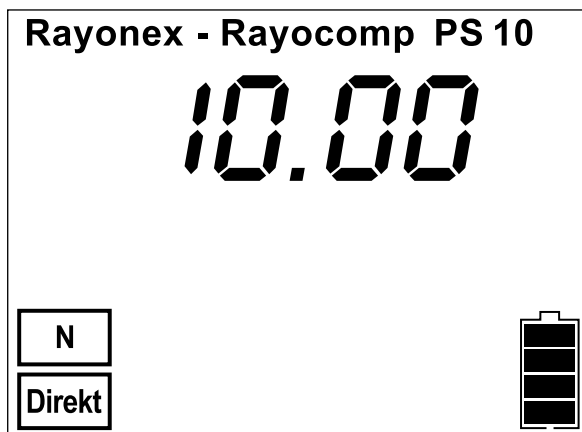

Note:

Please note, that entering commas is, in this case, optional. However, the comma can be helpful when entering one-digit values.

That's why the entry



of the Rayocomp PS 10 is interpreted as a fundamental frequency value of 9.00.

Please press now the following keys:

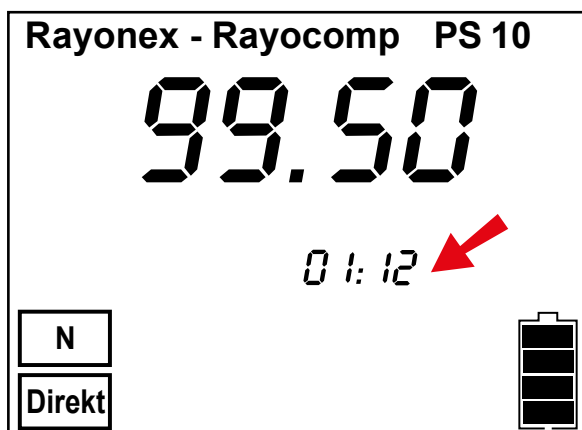

The Rayocomp PS 10 sets the fundamental frequency value 99.50 and displays:

Beneath the fundamental frequency value you can see numerals indicating the running time (here: 1 minute and 12 seconds).

With the help of the Rayotensor the test can now begin.

A linear movement at the Rayotensor = resonance (unstable field). Rotation at the Rayotensor = no resonance (stable field)

A new fundamental frequency value can be set at any time.

3.1.8 Automatic program sequence when using an RAH Green Card in menu item "Direct"

A special function has been added to the Rayocomp PS 10 under the menu item "Direct". If you insert a Green Card, an automatic harmonisation sequence begins. The single frequency basic values stored on the Green Card are automatically harmonised with 30 seconds each. Thus, clients can easily use a Green Card compiled by the therapist for home therapy with a Rayocomp PS 10 basic.

For the automatic program sequence under the menu item "Direct" you have to do the following:

1. The stored RAH Green Card into the memory card slot.
2. The Rayocomp PS 10 can now read the fundamental frequency values stored on the memory card and harmonise with them. You must remove the Green Card from the card slot immediately after loading.
3. The automatic harmonisation sequence begins.

At first, the fundamental frequency values, stored on the Green Card, are set-up. The display shows i.e.:

Then the automatic harmonisation of the loaded frequency base values begins with the individually stored harmonisation times.

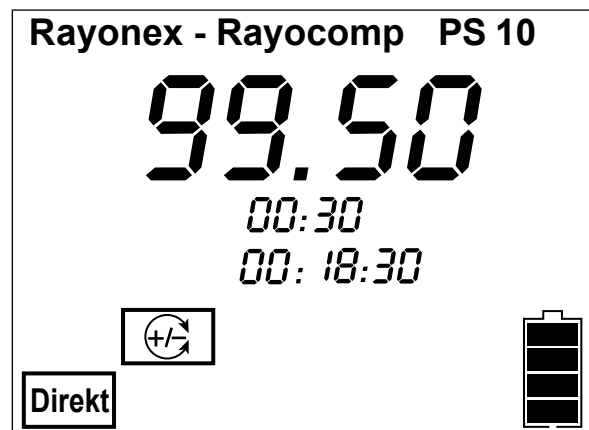

Note:

Using the Rayotensor, each single fundamental frequency value can be switched forward, if, e.g., the Rayotensor shows, that the harmonisation has been finished ahead of schedule.

4. Use of bioresonance according to Paul Schmidt in the field of wellness/well-being

The term wellness or well-being encompasses various methods and treatments which can enhance a person's physical fitness, mental agility and spiritual resilience. Holistic well-being and an increased quality of life are the goals of all the applications.

The Rayocomp PS 10 supports every user quite individually on the road to holistic well-being with an energy-based frequency test, so-called range-value testing.

Just as sunlight (nothing other than a frequency spectrum) tans our skin by allowing pigments to form or activating the vitamin D metabolism, there are a large number of other frequencies that are able to support the body's energy regulation mechanisms that are ultimately necessary for holistic well-being.

With an individual energy-based range value test, the Rayocomp PS 10 identifies exactly the frequency ranges required to harmonise the body's own energy. The "energy fingerprint" obtained in this way comprises basis frequency values that can be allocated to the physical, energy and mental levels in the organism.

The Rayocomp PS 10 with its range value test offers the ideal basis for a targeted energetic harmonisation of the organism, which ultimately can contribute to holistic well-being.

To perform a range value test using bioresonance according to Paul Schmidt, module 06 (13 test programs, incl. quick meridian test) must be activated in the Rayocomp PS 10.

4.1 Summary of the functions of the Rayotensor in BaPS:

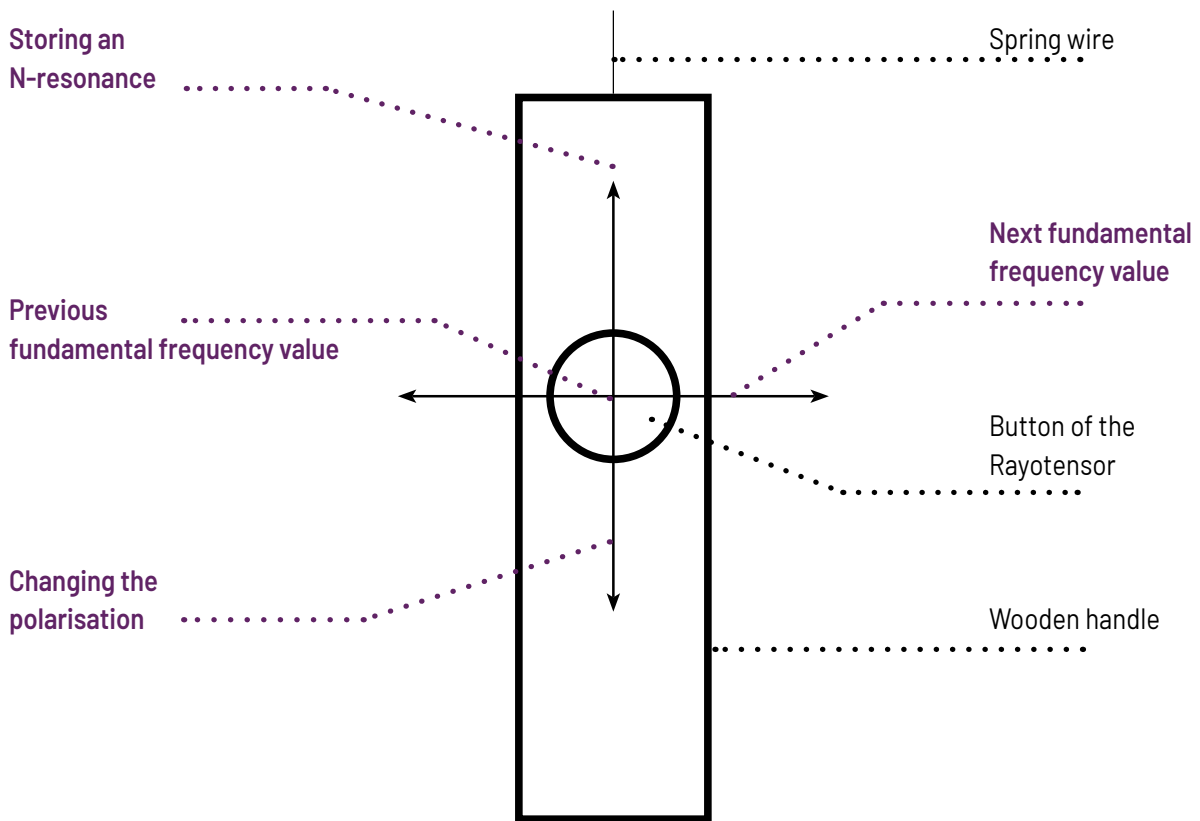

4.2 Use of the BaPS in wellness/well-being

In the following we will explain how the range value test in the wellness / well-being field is carried out.

Select the menu item "Test-BaPS" with the **MODE** key.

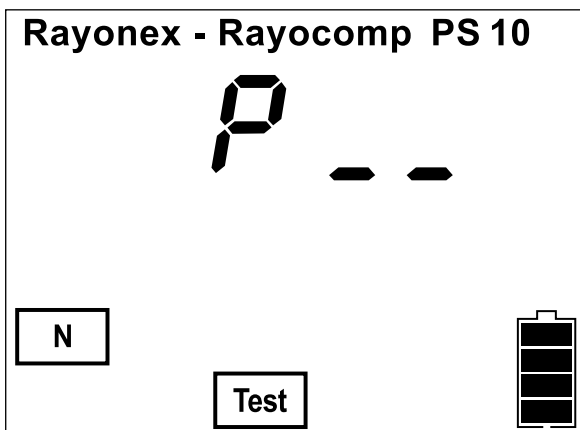

Just like the menu item "F1", "Test" is separated in "BaPS" and "RAH", however, the menu item "RAH" is only displayed when a corresponding module from the RAH is activated (Module 7 to 12).

Here you enter the number of the corresponding test program.

Display	Program name
P 01	Testing with range values
P 02	Test with memory card values
P 03	Test with integrated programs
P 04	Electro-magnetic pollution test
P 05	Geopathy test
P 06	Check-up test
P 07	Bacteria and viruses test
P 08	Parasite test
P 09	Acid-base test
P 10	Quick test of the 14 meridians
P 11	Vital substance test
P 12	Building biology (topic related)
P 13	Building biology (numerical)

If you enter 01 you can carry out a range value test; with 02, the fundamental frequency values of a memory card can be read into the device for subsequent testing. With 03, you can test all programs integrated in your device as a module. The test programs 04 to 13 are special compilations of fundamental frequency values. You can use them if module 6, test programs, is activated in your Rayocomp PS 10.

Important information:

The fundamental frequency values tested with resonance can be saved on an inserted memory card at any

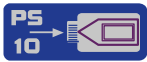
time by pressing the key . You can read in the fundamental frequency values from a memory card, test them and save the so determined resonances on the same card again, for instance. This makes sense for subsequent testing of the resonances of a range value test. Please keep in mind that you overwrite all values previously stored on the memory card when you press the key.

So you see that the program number determines the fundamental frequency values which are going to be tested. As soon as the values intended for testing are available, the test run is always the same.

You will see the following picture on your display, if, for example, the testing range values with the pre-set values are selected.

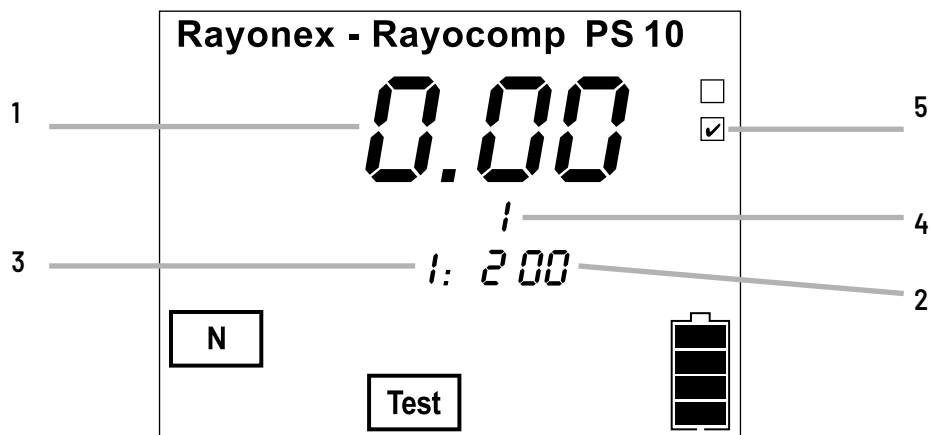

With this display, the Rayocomp PS 10 informs you about which fundamental frequency value is being tested at present (1), how many fundamental frequency values are going to be tested altogether (2), how many fundamental frequency values have already been tested (3), how many fundamental frequency values have caused a resonance (4) and whether the currently displayed fundamental frequency value is a resonance value (5).

With the help of the sensor, you can find out whether there is any resonance and if this resonance is strong or weak. As a practical feature while testing, you can set the next value or store the current value with the sensor).

4.3 Testing range values

The idea behind this test is to find out all the fundamental frequency values in disorder at the moment, then to store and harmonise them. With bioresonance devices according to Paul Schmidt, it is possible to conduct a resonance test across a broad range of fundamental frequency values. In practice, this is how it works: beginning with the fundamental frequency value 0,00, you start testing whether this fundamental frequency value is required for regulation. If this is the case, it is stored in the Rayocomp PS 10. Carry on by testing the fundamental frequency value 0.50, then 1.00 and so on. After the test, precisely those resonance values necessary for regulating the organism of the client have been determined. In a way, the detected resonance spectrum presents the energetic fingerprint for holistic well-being.

And this is the method for performing the range value test:

Select the menu item "Test" with the key  .

According to the table (Chapter 4.2), enter the number 01 and confirm the input with the OK key. You will see the start value of the test on your display. If you have made the right choice, please confirm with the OK button. After this, the concluding value is displayed, which is confirmed with the OK button again. Now you have the chance to alter the step lengths or to confirm the indicated length with the OK-key. We recommend the start value 0.00, the final value 99.99 and a step length of 0.50. With this set-up, 200 values will be tested. Now you can follow the description for testing fundamental frequency values to find resonances.

4.4. The Green Card

The storage of fundamental frequency values on a Green Card is carried out without specifying the polarity, since in automatic harmonisation both + and - polarities are always offered bipolarly to the organism for harmonisation.

Years of experience have shown that in the case of a bipolar offer, the organism independently chooses which form of optimal support it needs with regard to harmonisation.

The contents stored on the Green Card can also be deleted, overwritten or write-protected.

A special function has been added to the main menu of the Rayocomp PS 10. If you insert a Green Card, an automatic harmonisation sequence begins. Immediately after the start, the single-frequency basic values stored on the Green card are harmonised with 30 seconds each. This means that clients can very easily use a Green card compiled by a wellness therapist for home therapy in the field of wellness with a Rayocomp PS 10 basic.

4.4.1 Saving fundamental frequency values con a Green Card

Once all fundamental frequency values from the range value test have been tested and the energetically blocked fundamental frequency values have been stored via the Rayotensor, the test result can be stored on a "Green Card" for future harmonisations or renewed testing.

The Green Card is inserted into the card slot. By pressing the key:  the stored fundamental frequency values are stored on the Green Card.

4.4.2 Testing with Memory Card Values

With the Rayocomp PS 10, it is very easy to save fundamental frequency values on a memory card. The values stored on the card can be used for harmonisation via menu item "F1". The values on the card can also be used for testing.

And this is the way it works:

Select the menu item "Test" with the  key.

Insert the memory card and enter number 02. The Rayocomp PS 10 reads in the values from the memory card and changes over to the "Test" mode as described before.

4.4.3 Automatic harmonisation

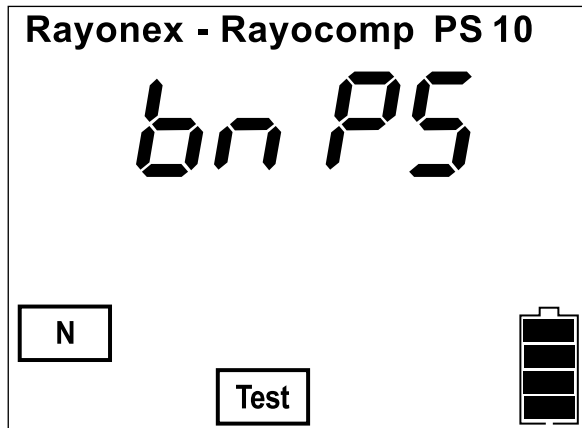

After the last fundamental frequency value has been tested, press the key **MODE** to switch to F1 BaPS, enter

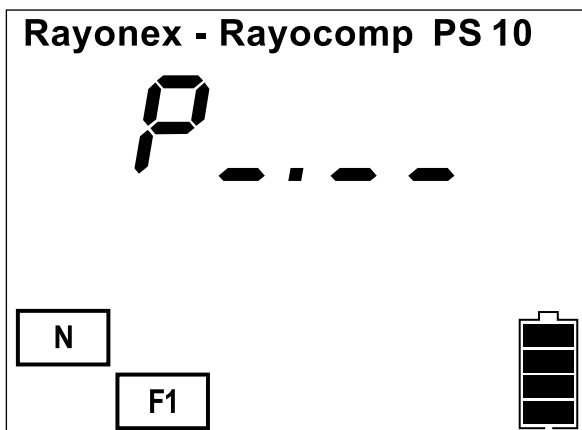

00.0, press **START** and once again you will have the possibility to change the harmonisation time.

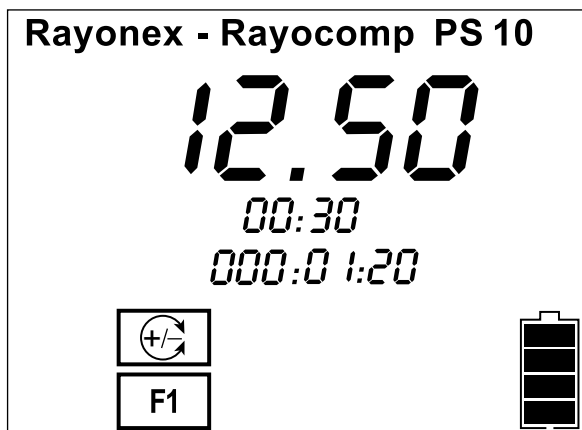

If the specified harmonisation time 00.30 sec./FFV is confirmed with OK, the automatic harmonisation of the stored fundamental frequency values with the bipolar polarity starts.

4.4.4 Loading Fundamental Frequency Values from Memory Cards and Harmonising

We have already explained how the menu function "F1-BaPS" offers all possibilities to compile fundamental frequency values. Of course, this also includes the use of the Green Card. For example, if you have stored the resonance values of a range value test on a Green Card, you can use them to harmonise automatically in "F1-BaPS".

To do so, select the menu item "F1" with the key .

The display shows:

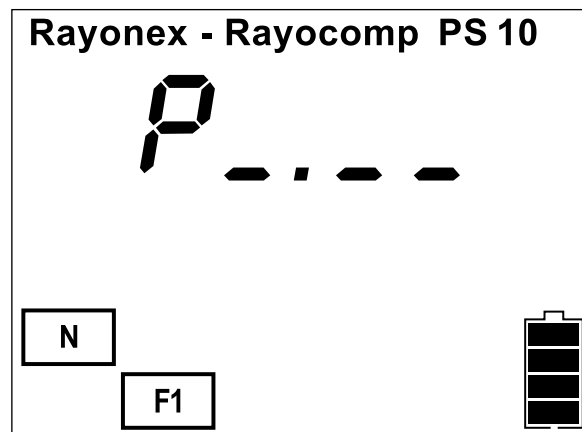

Now insert the memory card in the Rayocomp PS 10 and press the following key: .

The Rayocomp PS 10 can now read the values stored on the memory card and harmonise with them.

Tip: In menu item "Setup" you can save fundamental frequency values on a memory card.

5. "Setup"

The menu item "Setup" was designed to adapt the Rayocomp PS 10 to your individual needs by means of pre-settings. Available besides the alteration of pre-sets are test functions and important and useful functions in connection with memory cards.

Select the menu item "Setup" with the key **MODE**. The display shows:

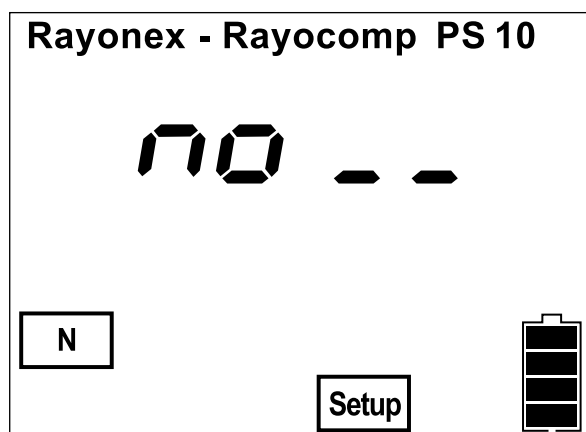

At this stage, the device is waiting for a set-up number to address the desired set-up function. For example, if you want to enter the setup number 10, please press 1, then 0 and confirm your entry with the OK key. Further actions are described in the following sub-chapters.

To simplify orientation, the layout of the set-up numbers is large and marked in red in the corresponding sub-chapters.

Please note: You run no risk of ruining the device or deleting anything permanently if you alter the set-up. Every set-up of the device can be returned to its original state. Have courage and try it out. It is the best way to become familiar with your Rayocomp PS 10.

5.1 Set-up of background illumination

Setup Number: 10

For reasons of improved legibility, the display of the Rayocomp PS 10 was provided with background illumination. Because of this feature, the display remains perfectly visible, even if the light is dim. You can select one of three different types of background illuminations. Enter the set-up number 10 and you can add one of the following numbers:

- 0: Background illumination is permanently switched off.
- 1: Background illumination is permanently switched on.
- 2: Background illumination is set to automatic. 30 seconds after the last keyboard action, the background illumination is switched off. The background illumination turns on again as soon as the keyboard is used. This saves energy, the battery pack lasts longer. With this set-up, the background illumination is switched off at night if you are harmonising while you are resting. Your sleep is not disturbed by the bright light of the illumination in the background.

On delivery, the standard set-up of the Rayocomp PS 10 is number 2.

5.2 Deleting double values in the F1 programs

Setup Number: 11

If you are compiling different BaPS programs, it is inevitable that several of the fundamental frequency values are repeated. If you prefer not to harmonise and test fundamental frequency values twice, you can set this up here.

While testing the RAH programs, double RAH-programs (e.g. from the memory card) are always rejected and are only selected once. While harmonising RAH programs, double RAH programs are maintained.

Enter the set-up number 11 and you can add one of the following numbers:

- 0: **Do not** delete double values when loading the F1 programs respectively RAH programs!
- 1: Delete double values when loading the F1 programs respectively double RAH programs when testing!

On delivery, the standard set-up of the Rayocomp PS 10 is number 0.

5.3 Adjusting the "Attention" sound (Beep)

Setup Number: 12

The Rayocomp PS 10 has been equipped with an acoustic signal. This may signalise e.g. the use of a wrong key or confirm an entry.

The Rayocomp PS 10 has three different error messages or acoustic signals:

1. **One long sound:** with this signal, the device confirms a successfully completed action, i.e. an entry or storage.
2. **Two short sounds:** The key you are pressing has no current function.
3. **Two long sounds:** This signalises a severe error. The device will supply an error code. In the appendix (Chapter 7), you can look up the current error.

This set-up function enables or disables the signal. Enter the set-up number 12 and you can add one of the following numbers:

- 1: The acoustic signal is switched on.
- 0: The acoustic signal is switched off.

On delivery, the standard set-up of the Rayocomp PS 10 is number 1.

5.4 Pre-Setting the Test Range Values

Setup Number: 13

One of the most successful methods of bioresonance according to Paul Schmidt is the range value test. Beginning with a start value, usually 00.00, and closing with a final value, usually 99.99, in step lengths of, 00.50 i.e. every single fundamental frequency value is tested for a resonance and then harmonised. These three values can be pre-set in this set-up function. After entering the set-up number 13, you can enter the start value first. After pressing the **OK** key, you can enter the final value. As soon as this has been confirmed with the **OK**-key, the step length can be pre-set, perhaps to a smaller value of 0.25. As always, the step length is confirmed with the **OK**-key.

Here is the standard set-up of the Rayocomp PS 10 on delivery:

Start value: 00.00
 Final value: 99.99
 Step value: 00.50

5.5 The pre-setting of the harmonisation time for fundamental frequency values

Setup Number: 14

The pre-setting of the harmonisation time for fundamental frequency values can be very helpful for the use of a BaPS-F1 program, as well as for the use of a Rayonex Green Card. If, e.g. single frequencies and also RAH-programs were stored on a Green Card, the individual harmonisation times for the RAH-programs can be stored, but not for the single frequencies. If an automatic program sequence is started by the means of an Green Card, the default for the single frequencies can be regulated by the pre-setting of the harmonisation time. Standard is 30 seconds. If the harmonisation time has been changed in this set-up item to, e.g. one minute, every existing fundamental frequency value of the Rayocomp PS 10 is automatically harmonised with 1 minute, when using a Green Card.

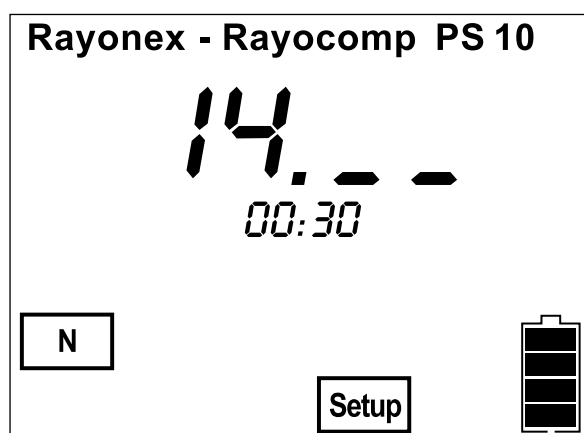

In the same way, when using the BaPS-F1 programs, the pre-set harmonisation time of this set-up item will be used.

After you have entered the setup number 14, confirm your entry with the **OK** key. The display shows the illustration as demonstrated here on the left.

00.30 means 00 minutes and 30 seconds. The cursor in the minute input field blinks first. For example, you can enter 0100 and confirm this with the key **OK**, and so 1 minute is pre-set.

To set the duration to 40 seconds, enter 0040.

5.6 Automatic switch-off at the end of harmonisation

Setup Number: 15

The Rayocomp PS 10 is often used for harmonisation during sleep.
The automatic switch-off of the device, after harmonisation, is regulated by setup number 15.

With this setup function you can switch the automatic switch-off on or off. Enter the set-up number 15 and you can add one of the following numbers:

- 0: The automatic switch-off is switched off.
- 1: The automatic switch-off is switched on.

On delivery, the standard set-up of the Rayocomp PS 10 is number 0.

5.7 Activating and Deactivating Modules

Setup Number: 20

After having entered the set-up number 20, you can select the number of the module (1) intended for activation or deactivation. (Please confirm each input with the OK-key.)

Here is the module number:

Module no.	Designation
1	Setup precision of 0.05
2	Bioresonance according to Paul Schmidt

Then please enter a seven-digit activation code, which you will receive from Rayonex, for activation or deactivation and confirm it with the **OK** button.

5.8 Storing Fundamental Frequency Values on Memory Cards

Setup Number: 30

A great advantage for anyone working with the Rayocomp PS 10 is the use of memory cards. They allow you to store individual frequency compilations which can be used for testing in the menu "Test" or for harmonising in the "F1-BnPS" menu. Generate your own memory cards with this set-up function. The frequency compilations can be stored on a normal memory card or a Green Card.

Insert the memory card in your device and enter the set-up number 30. Every entered fundamental frequency number will now be stored on your memory card as soon as you have confirmed it with the **OK** key.

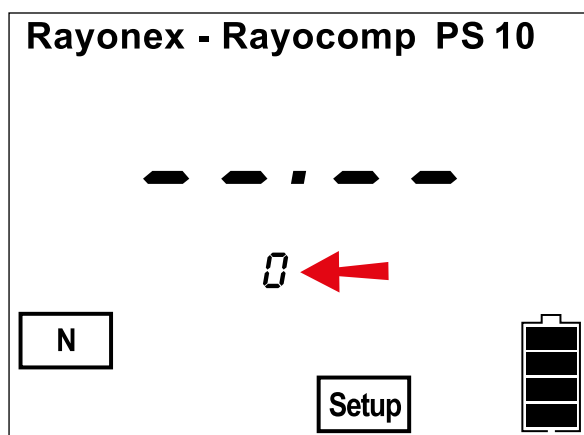

The display shows:

The red arrow points to the numeral which indicates the number of the currently stored values on your memory card.

With the key  you can delete the last value entered on the card.

Should the card contain left-over values which you want to delete, please use the set-up number 43.

5.9 Displaying Memory Card Information

Setup Number: 40

This set-up can help you if you have an unknown memory card and have no idea how many RAH VET programs are stored on it, what kind of a memory card it is and so on.

A "Green Card" can comprehend maximum 200 RAH VET values. You can detect the number of RAH VET programs from that figure, that is shown in the display with the 200 at the same time. (i.e. 34: 200)

Insert the memory card and enter the set-up number 40. The display may show:

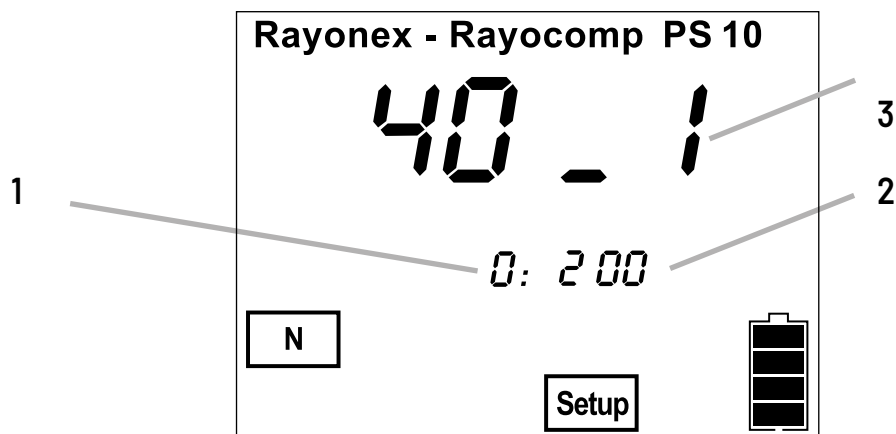

Legend:

- 1: This number indicates the amount of values already stored on the memory card.
- 2: Here you can read the number of values which can be stored on the memory card. An exception is the "Green Card". The "Green Card" can contain 500 BnPS- and 200 RAH values, which are shown by turns.
- 3: If you see a 0, the memory card is faulty. A number 1 indicates a memory card suitable for use when working with the bioresonance according to Paul Schmidt. If the displayed numeral is a 2, this memory card can be used for the B.A.T.-acute programs according to Manfred Denecke. A "Green Card" is indicated with a 3.

5.10 Providing Read-Protection for a Memory Card

Setup Number: 41

This set-up function provides a read-protection for the inserted memory card. If you use a read-protected memory card with a Rayocomp device, i.e. in "F1-BaPS", the fundamental frequency values are set up but not displayed. This may make sense when developing and testing new fundamental frequency values. Please insert the memory card intended for read protection in your Rayocomp PS 10. On entering the set-up number 41, the display will either show 0 (card is not read-protected) or 1 if the card already has read protection. A Green Card cannot be modified with a read protection.

If the card is still without read protection, please enter 1 and confirm your entry with the **OK** key. Please keep in mind: the read protection of a memory card can only be reversed by deleting it.

5.11 Providing Write-Protection for a Memory Card

Setup Number: 42

This set-up function provides a write-protection for the inserted memory card or rather remove it. A memory card with write protection cannot be deleted by accident, nor can other fundamental frequency values be stored on it.

Please insert the memory card intended for write protection in your Rayocomp PS 10. On entering the set-up number 42, the display will either show 0 (card is not write-protected) or 1 if the card already has write protection.

If the card is not write-protected yet, please enter the numeral 1 and confirm with the **OK**-key to provide write protection for your memory card.

If the number 1 is displayed to show that your memory card is write-protected, simply enter 0 and confirm with the **OK** key to remove write protection.

5.12 Deleting a Memory Card completely

Setup Number: 43

With this set-up function, you can delete a memory card completely, thus preparing it for new writing processes.

Whenever you delete a memory card with this function, you do not only delete the RAH-programs stored on it, but also any read or write protection added to the contents of the card.

Please insert the memory card you want to delete in your Rayocomp PS 10. Enter the set-up number 43 and wait until a 0 is displayed. For safety reasons, you must enter a 1 at this stage and confirm with the **OK** key.

5.13 Initialising a Memory Card

Setup Number: 44

If you should come upon a memory card with illegible sticker, you can test the card with this setup function and reinitialise it. The function works for the memory cards of the bioresonance according to Paul Schmidt and also for the Green Card.

When initialising the memory card with this function, the system values of the card are newly determined and written and all the stored RAH-programs are deleted. If the card is write protected, this is also deleted.

Please insert the memory card intended for initialisation in your Rayocomp PS 10. Enter the setup number 44 and wait until a 0 is displayed. For safety reasons, you must enter a 1 at this stage and confirm with the **OK** key.

5.14 Motor Test Run of the Frequency Module

Setup Number: 50

The user can test the mechanically driven frequency module of the Rayocomp PS 10 with this setup function. If your Rayocomp has been subject to jostling and vibration, perhaps during long transportation, you can make sure that the frequency module is still in perfect working order with this function.

After you have entered the setup number 50 and confirmed your entry with the **OK**-key, the Rayocomp PS 10 starts a trial run. You can read the progress of the trial run from your display. At the end, the device should display the following message:

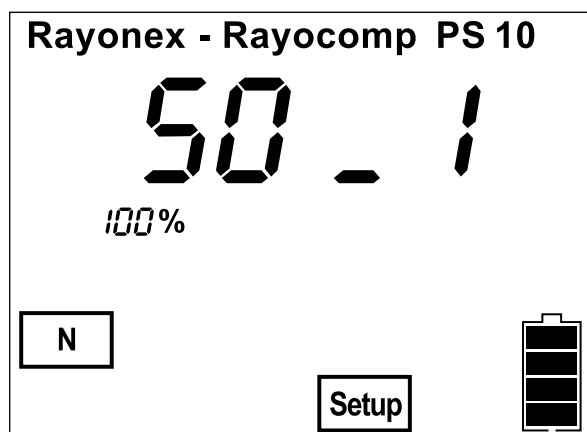

The 1 displayed behind the 50 indicates an optimal functioning of the frequency module. If you see a 0 in the same place, however, the trial run was faulty. Please repeat the trial run in this case. If the 0 appears again, your Rayocomp PS 10 has to be sent back to us.

5.15 Battery test

Setup Number: 75

Every Rayocomp PS 10 has a built-in rechargeable battery that enables mains-independent operation. Each battery loses its capacity over time, which also reduces the service life of the device. With this setup point you can test the current status of the battery.

Important: Before you carry out the test, the device must be fully charged.

After the Rayocomp PS 10 has been loaded, please select setup point 75.

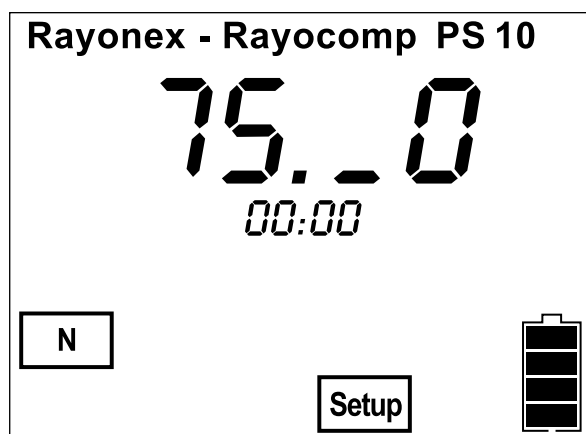

The screen displays:

Now press the **START** button longer than one second. The device now moves to a fundamental frequency value every 30 seconds until the battery is empty and the device switches itself off (new PS10 generation. The older PS10 generations will show Error29 as these don't switch themselves off automatically).

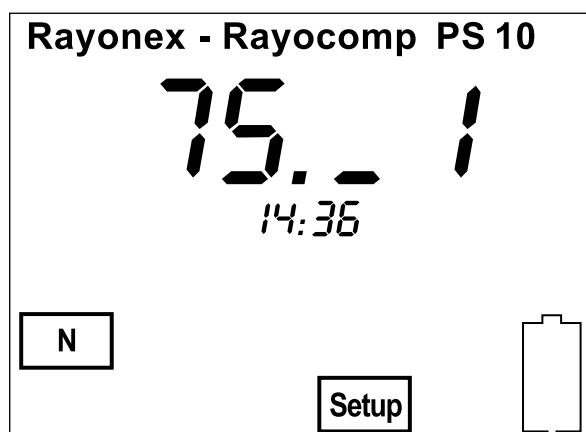

While running, the device saves the current running time. Do not use the device while the test is running and do not recharge it until it has switched itself off, or displayed Error29.

After switching on again, please go back to setup point 75. The display then shows you the current running time, which allows conclusions to be drawn about the capacity of the battery.

In this example it is 18 hours, 35 minutes.

If the running time is less than 12 hours, we recommend replacing the battery.

6. "Info"

In the menu item "Info" you can look into all important details concerning the device, quickly and conveniently.

You arrive in the menu item "Info" by pressing the key **MODE** several times until the display below appears:

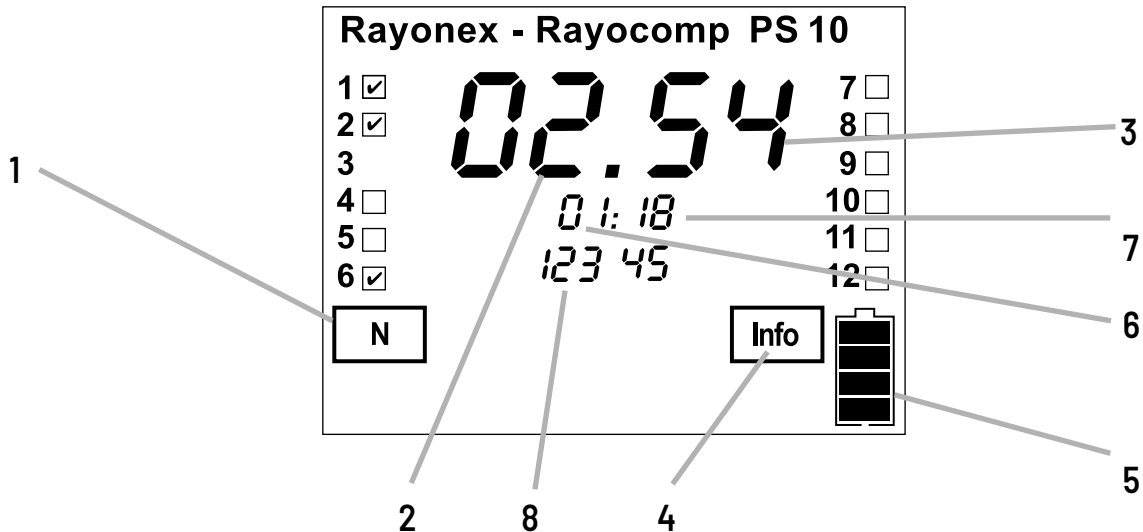

In the picture you can see that module 2 has been unlocked.

Legend:

- 1: Here, the currently set polariser mode is indicated. This is no special information, the polariser setup is visible in other menus, too. But for the sake of completeness, this is also displayed here.
- 2: This number informs you about the hardware version of the device, in this case the version 02. Devices including the version 02 have already been prepared in such a way that the RAH module can be activated by means of an activating code. Devices with the version 01 would first have to be modified. To this purpose, please contact the Rayonex company.
- 3: This number informs you about the software version of the device, in this case the version 54.
- 4: This indicates the currently active menu item.
- 5: This symbolises the load condition of the battery pack.
- 6: This number stands for the construction month of the device, in this case January.
- 7: This is the construction year of the device. In the example it is the year 2018.
- 8: These five numerals are the serial number of the device. The number, in our case 12345, is important for the definite classification of the device. Rayonex maintains a database with all the information concerning the device (i.e. the activated modules, etc.).

If you are thinking of enabling a module in the Rayocomp PS 10, you can call us and tell us your serial number to receive an enabling code. After entering this code, you can utilise the module immediately.

6.1 Special Function Keys

The Rayocomp PS 10 has a total of four special keys equipped with certain functions.

Important: These four keys can only be operated in the menu "Direct".

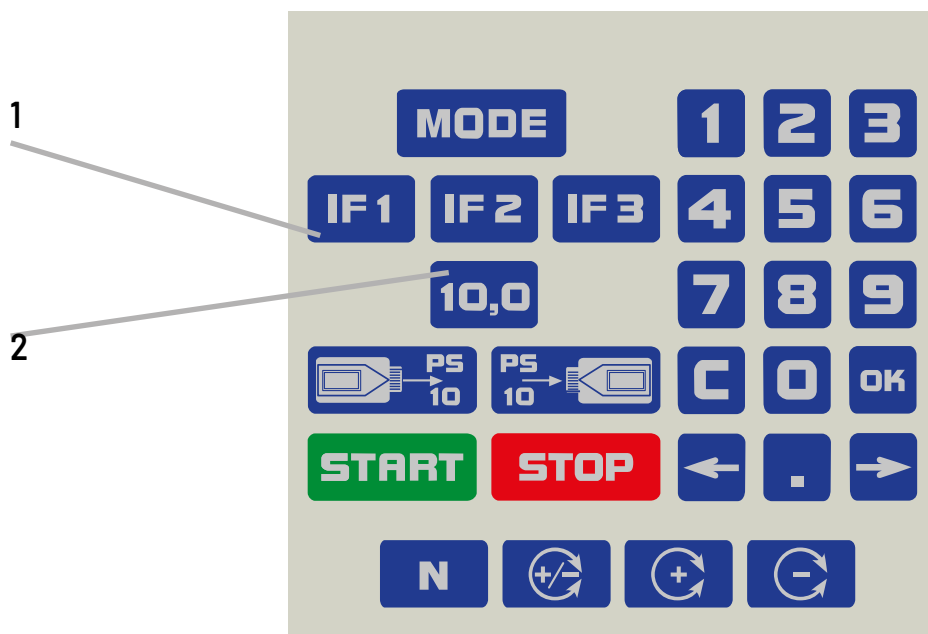

Legend:

1: three IF-keys, IF 1, IF 2 and IF 3

2: the 10.0-key

6.1.1 Using the IF-keys

You can use the IF-keys (Individual Fundamental Frequency Value) to store often used fundamental frequency values. They work like the station selection buttons of a radio. First you tune in to the radio station, then you keep the key pressed for a while until the station is stored. The function of the IF-keys is exactly the same. Enter the desired fundamental frequency value in the menu item "Direct". Confirm the entry with OK. Then press the desired IF-key until you hear a signal. Now the value is stored and can be called up at any time by pressing this IF-key. You can store three different fundamental frequency values in this way (IF 1, IF 2 and IF 3).

6.1.2 Using the 10.0-key

The key **10.0** is permanently linked to this fundamental frequency value. This often needed fundamental frequency value (allergen harmonising, energy, duplicating, ...) is called up rapidly with the special key whenever you want. Furthermore, this key has a special function in the module M10.

7. Summary of the Possible Error Messages

No.	Description
11	Wrong memory card type
12	Invalid memory card
13	No card inserted
14	Harmonising time must be at least 1 second
15	This setup item is vacant
16	Invalid module enabling code
18	Final value must be larger than initial value
20	Faulty motor contact. If this is a frequently occurring malfunction, the device must be sent in.
22	Card is write-protected
23	Module is not activated
24	Number of selected resonance values is too large for the card
25	It is not possible to provide read and write protection for this card
26	Maximum capacity of the memory full
27	This module has already been enabled temporarily
28	No Green Card inserted
29	Very low current! Charge battery pack!
31	This program group is non-existent
32	Close current program first by pressing the stop key twice
33	Test program is non-existent
36	Storage values contain read-protected values which cannot be stored
37	Card was removed in storing process
38	The polariser failed to switch to the selected mode. If this is a frequently occurring malfunction, the device must be sent in.
39	Hardware error of the RAH module
40	Please remove the card from the card slot
41	This RAH program can only be accessed using the right-flashing module.
42	More than 200 RAH-programs were selected
43	Double value
44	Problem occurrence when writing one value
45	Reading from the Green Card only works beginning from module 9
47	This program does not exist. An up-date is advisable
50	Unplug the charger from the PS 10; only charge the PS 10 when switched off
54	Selected program number is non-existent (see program list)
55	Wrong code
56	Module 10 is not active

No.	Description
65	There are only the modules 1-10
84	This RAH program is a training program; no level test possible
85	This RAH program is not available
86	A maximum of 200 RAH programs can be loaded successively
87	No values on the memory card
88	No "valid" memory card inserted. Please check or, if necessary, reinitialise the card (see Set-up Item 40 or 44, respectively)
89	More than 500 values selected in F1
90	This F1 program is non-existent (see program list)
92	This module cannot be activated by the present hardware version. In case you are interested in the RAH-Module, please contact the Rayonex company.
99	Program error

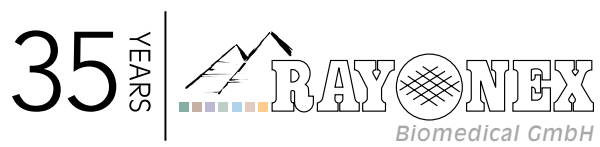

Rayonex Biomedical GmbH

Sauerland-Pyramiden 1, 57368 Lennestadt (Germany)

Tel.: +49 2721 6006-0 | Fax: +49 2721 6006-66

info@rayonex.de | www.rayonex.de

© Art. no.: 91035EN | Rev004 | Version: 30.11.2021